

JAEGER

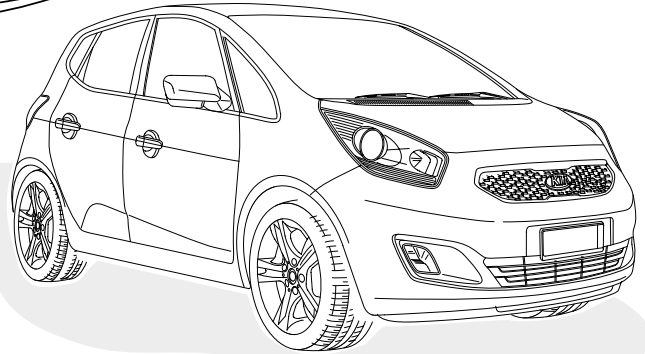
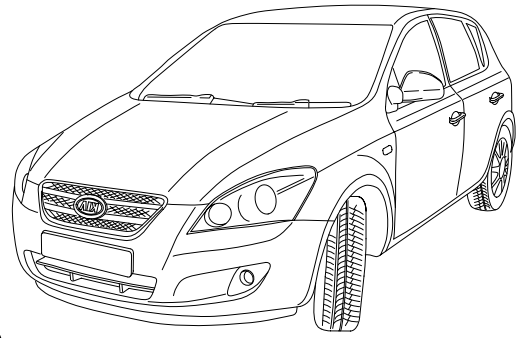
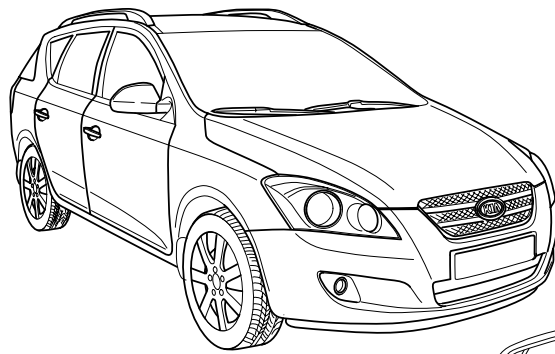

KIA Ceed 01/07 >>

Pro Ceed 01/08 >>

KIA Ceed Sporty Wagon

09/07 >>

KIA Venga

02/10 >>

722277

Check-Control

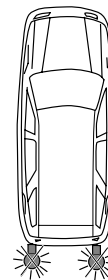
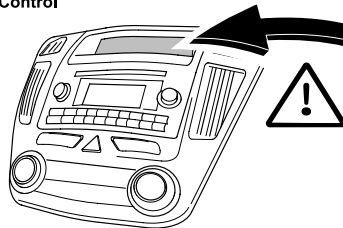

- (D)** Einbauanleitung
- (GB)** Installation instructions
- (F)** Consignes de montage
- (NL)** Montagehandleiding
- (DK)** Montagevejledning
- (N)** Monteringsinstruksjon
- (S)** Installationsanvisning
- (FIN)** Asennusohje
- (I)** Istruzioni per il montaggio
- (E)** Instrucciones de montaje
- (P)** Instruções de montagem
- (GR)** Οδηγίες εγκατάστασης
- (CZ)** Návod k montáži

- (PL)** Instrukcja montażu
- (TR)** Montaj talimatı
- (H)** Beépítési útmutató
- (HR)** Upute o ugradnji
- (BUL)** Инструкция за монтаж
- (RO)** Instrucțiuni de montaj
- (RU)** Инструкция по монтажу и установке
- (LT)** Montavimo informacija
- (LV)** Iemontēšanas pamācība
- (EST)** Paigaldusjuhend
- (SLO)** Navodilo za vgradnjo
- (SK)** Montážny návod

ERICH

Check-Control

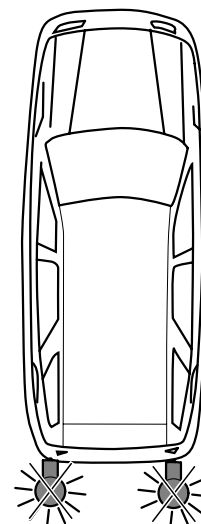
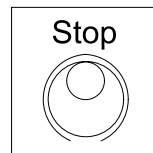
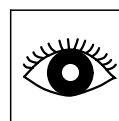
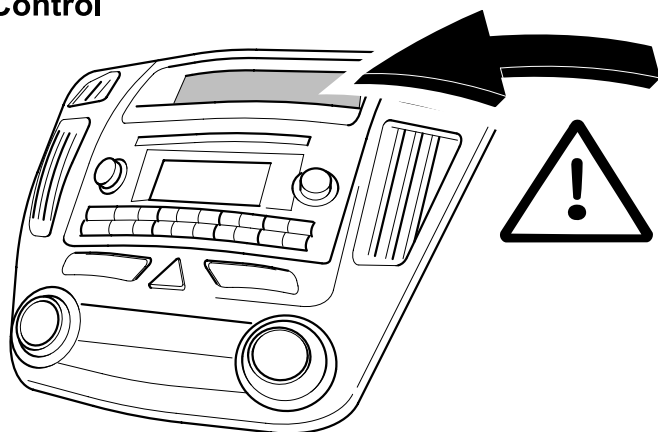

KIT

722277

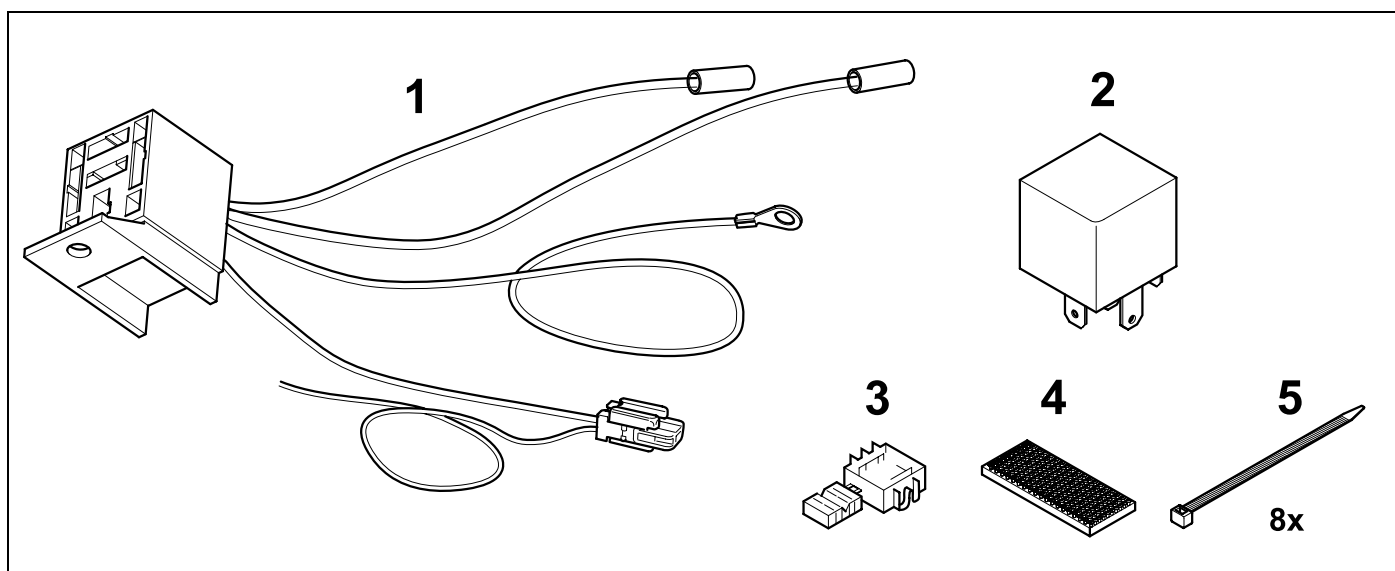

TOOLS

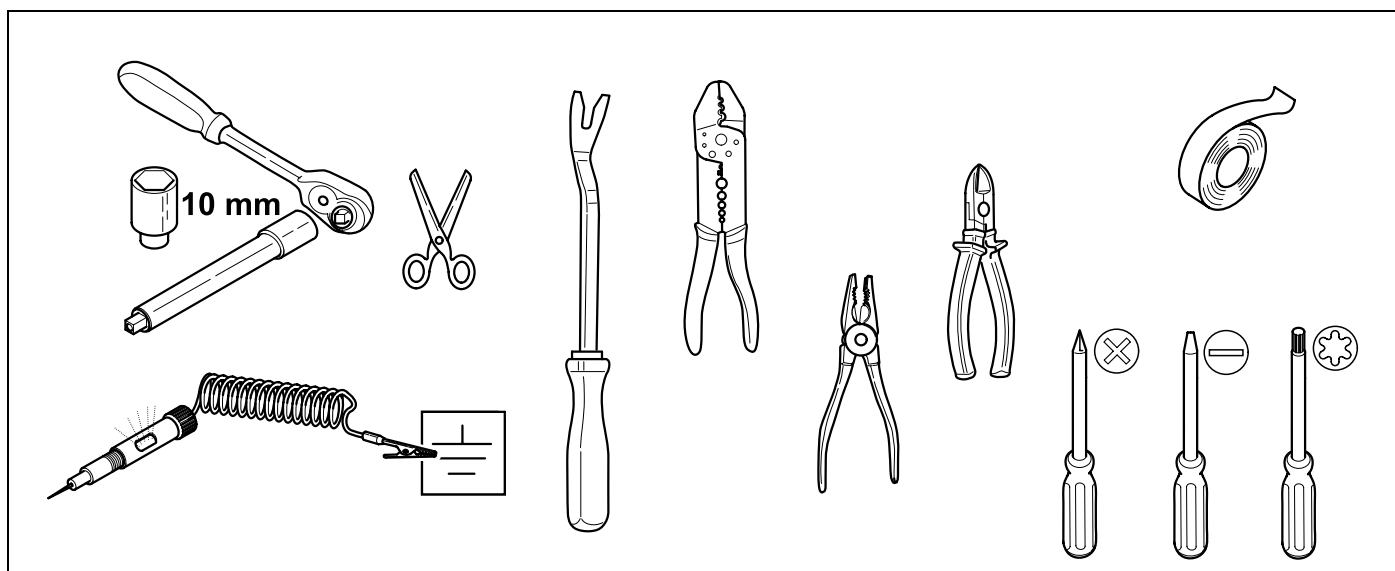

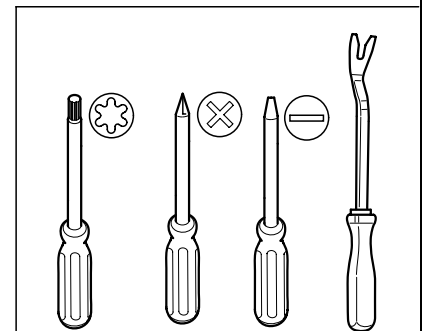
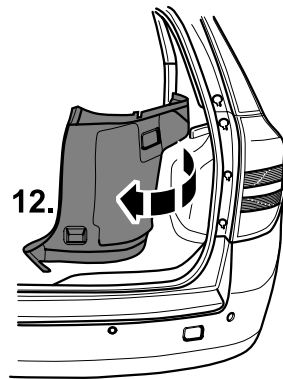
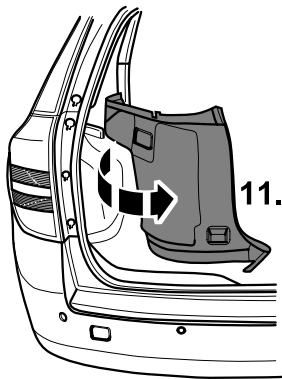
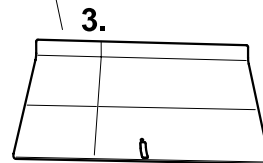
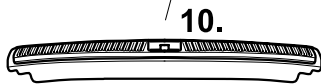
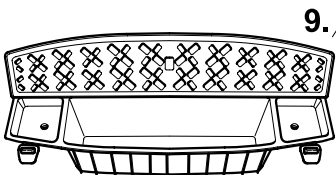
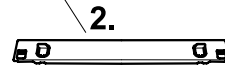
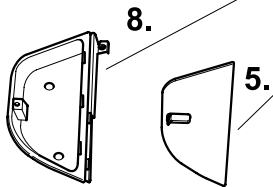
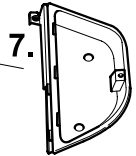
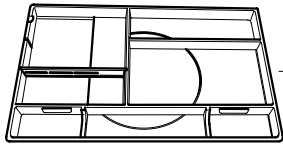
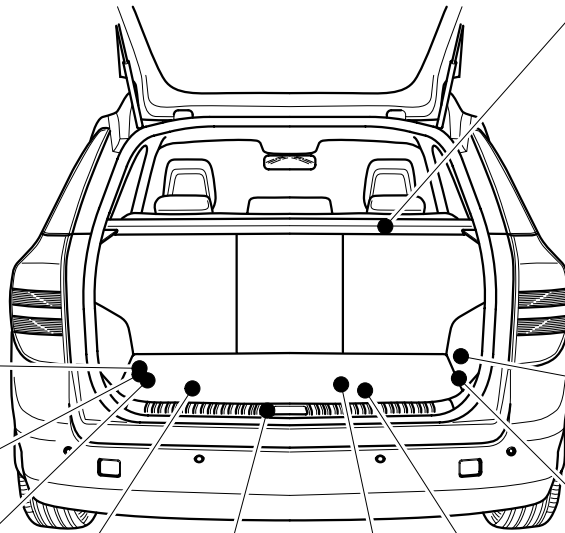
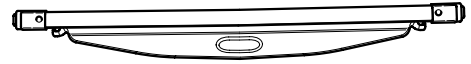
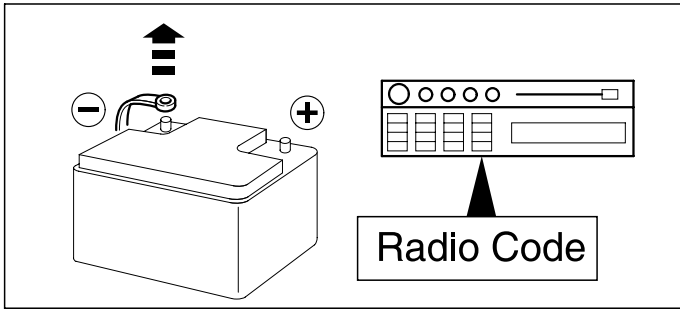

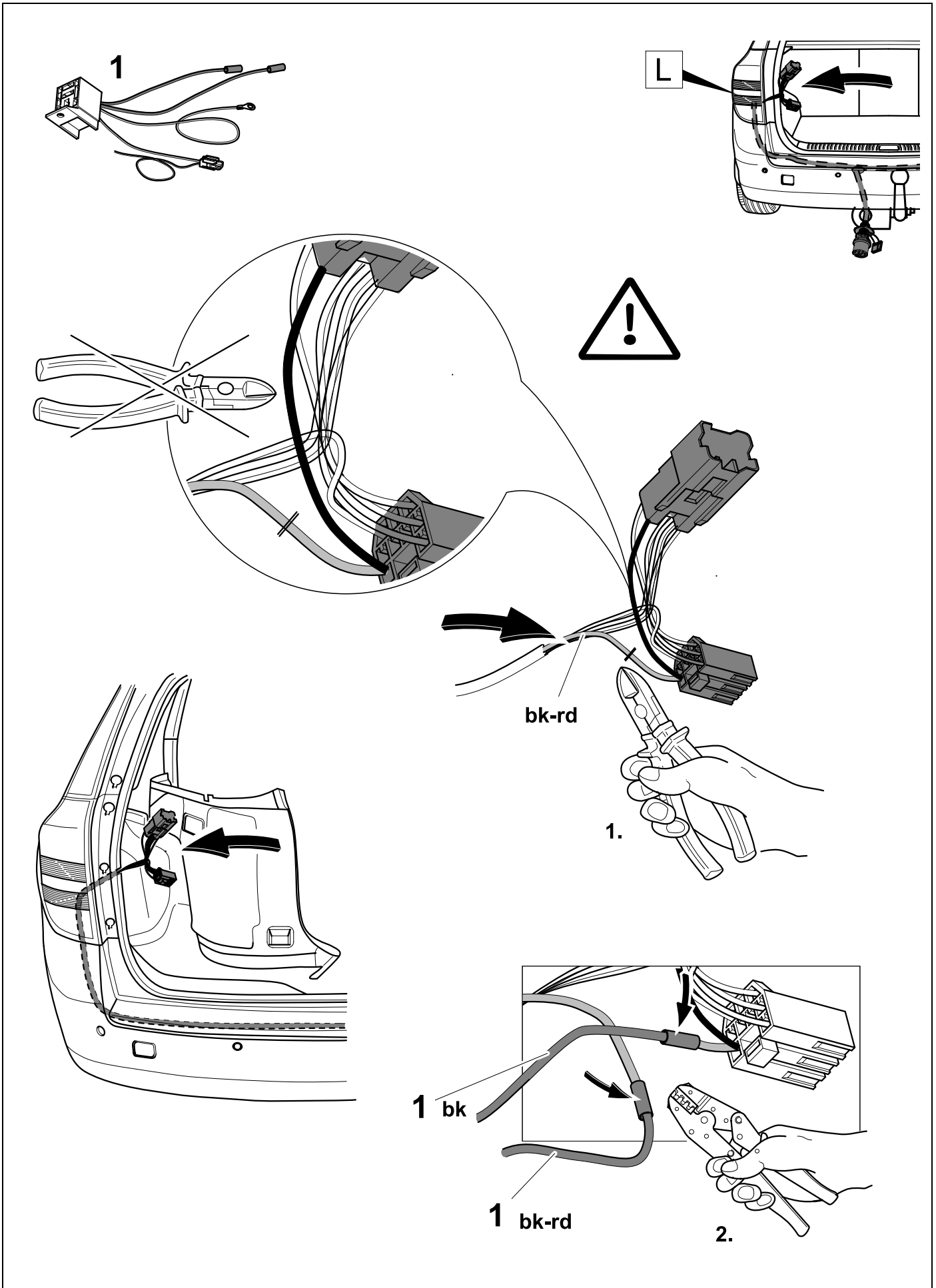

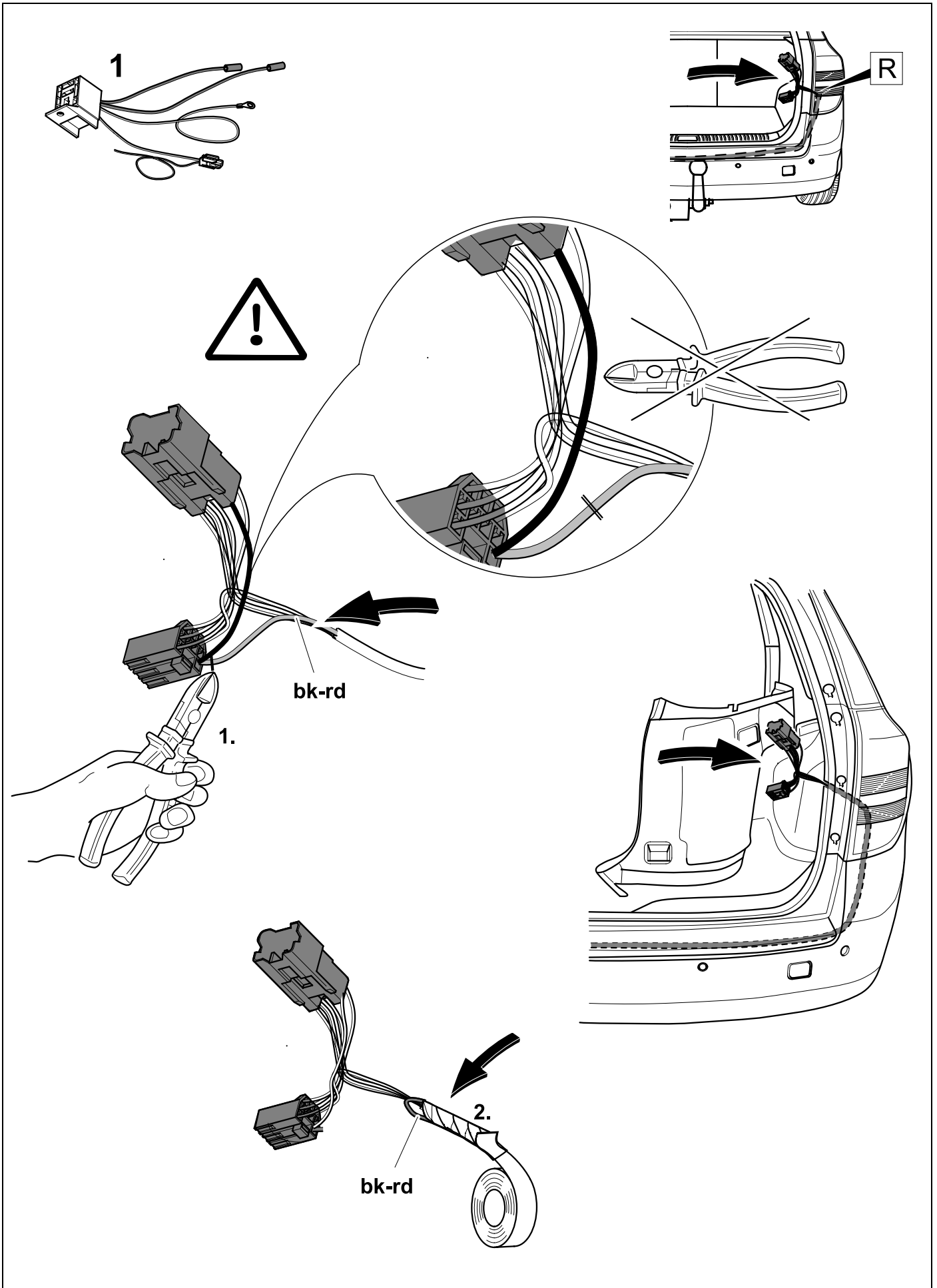

4

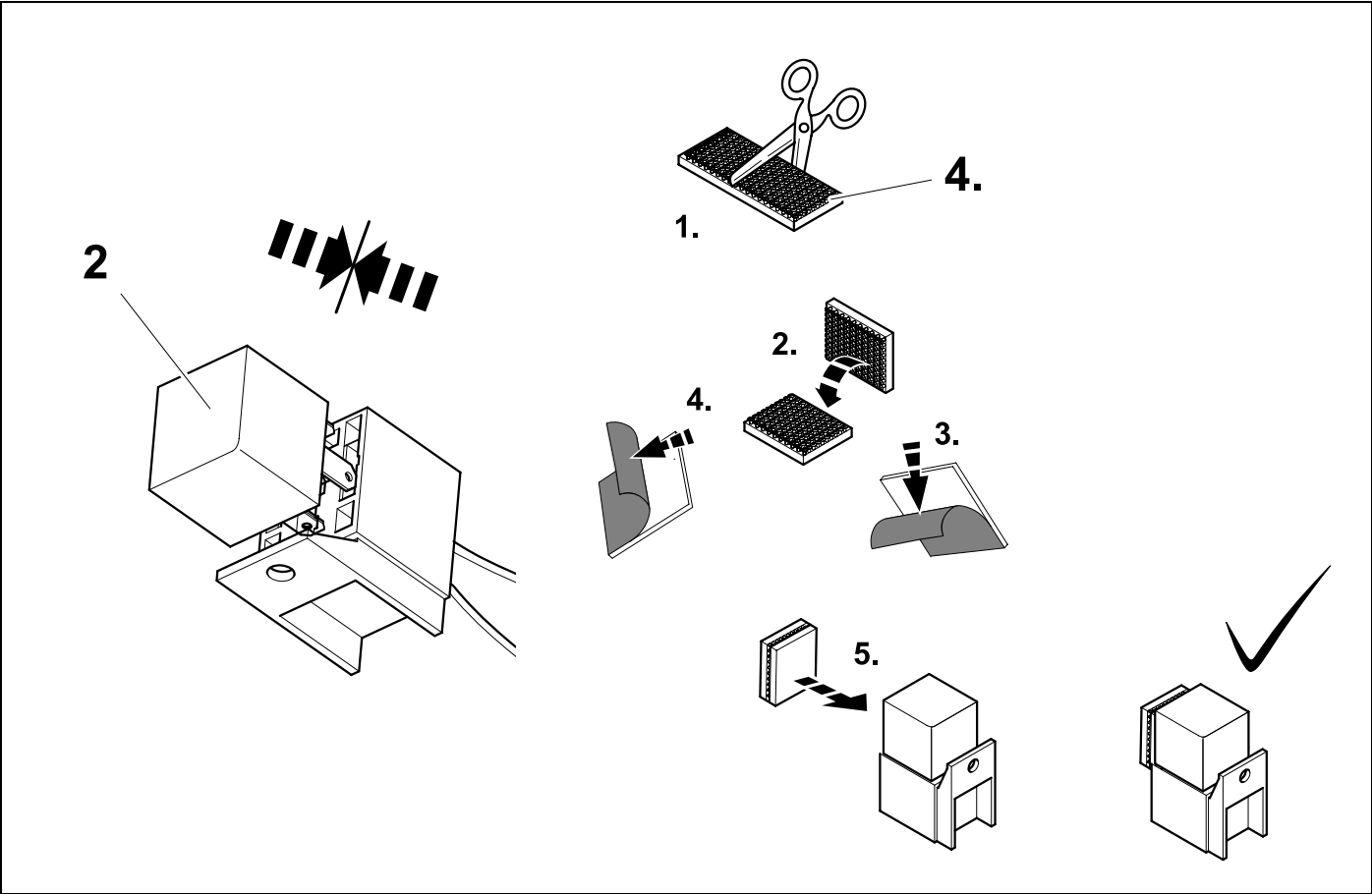

5

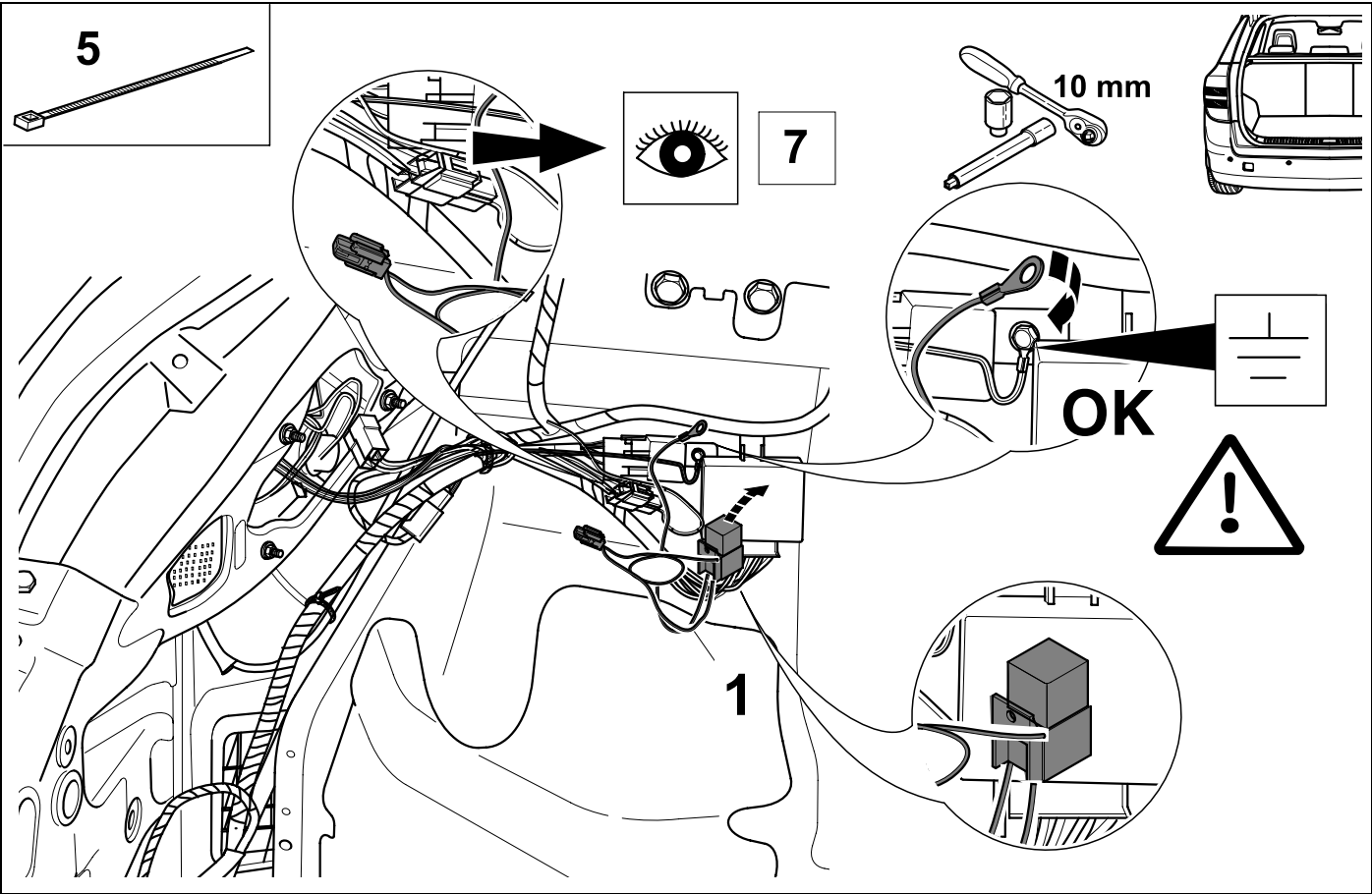

6

👁️ ⇒ 7

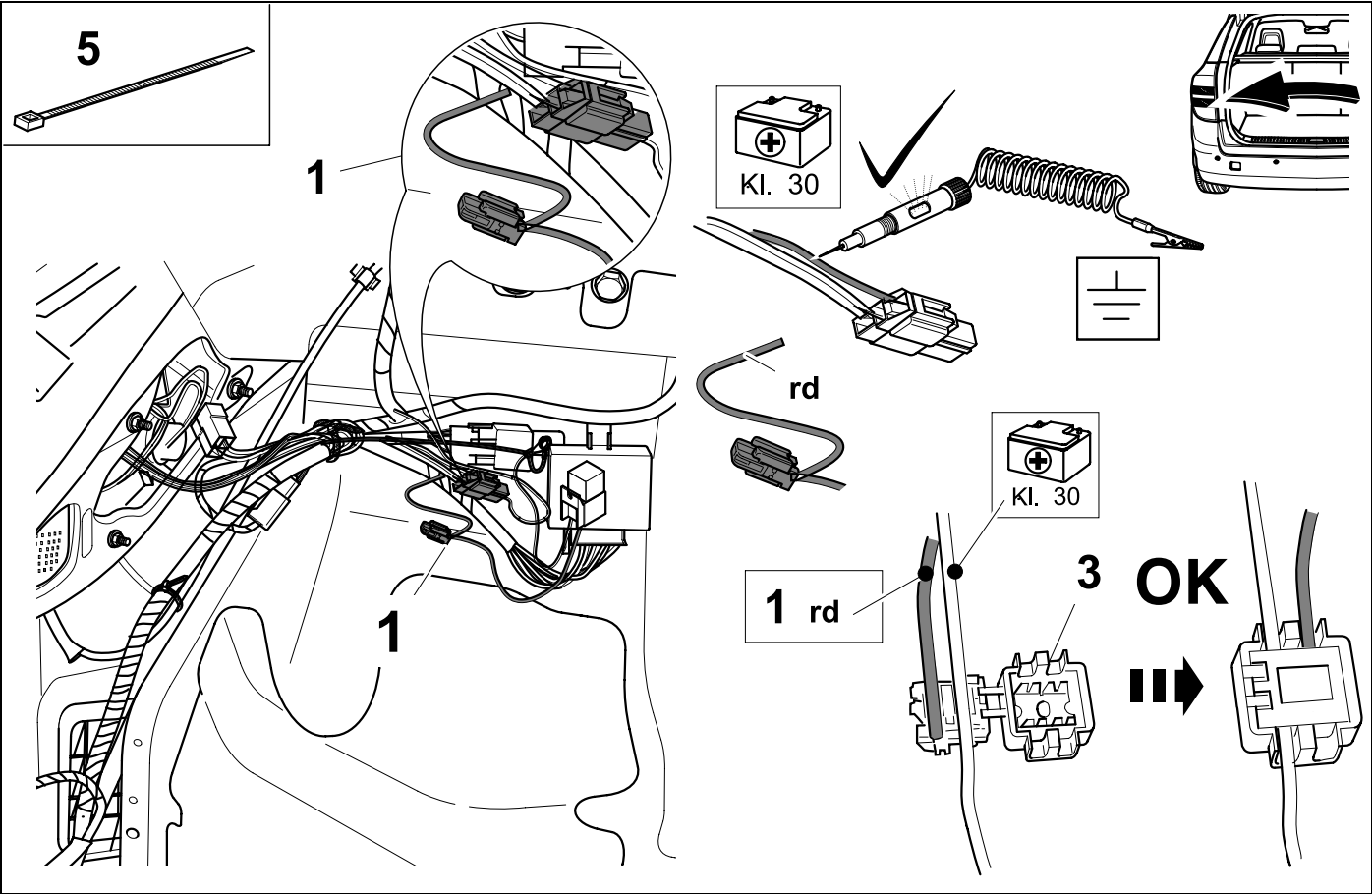

7	bk	wh	gy	gn	rd	bu	ye	bn	pu	or	no
(D)	schwarz	weiss	grau	grün	rot	blau	gelb	braun	violett	orange	nicht belegt
(GB)	black	white	grey	green	red	blue	yellow	brown	purple	orange	not occupied
(F)	noir	blanc	gris	vert	rouge	bleu	jaune	brun	violet	orange	inutilisé
(NL)	zwart	wit	grijs	groen	rood	blauw	geel	bruin	violet	oranje	niet aangesloten
(DK)	sort	hvid	grå	grøn	rød	blå	gul	brun	violet	orange	ikke anvendt
(N)	svart	hvit	grå	grønn	rød	blå	gul	brun	fiolett	oransje	ikke i bruk
(S)	svart	vit	grå	grön	röd	blå	gul	brun	violett	orange	ej använd
(FIN)	musta	valkoinen	harmaa	vihreä	punainen	sininen	keltainen	ruskea	violetti	oranssi	ei varattu
(I)	nero	bianco	grigio	verde	rosso	blu	giallo	marrone	viola	arancione	libero
(E)	negro	blanco	gris	verde	rojo	azul	amarillo	marrón	violeta	anaranja-do	no ocupado
(P)	preto	branco	cinzento	verde	vermelho	azul	amarelo	castanho	violeta	laranja	não ocupado
(GR)	μαύρος	λευκός	Γκρι	πράσινος	κόκκινος	μπλε	κίτρινος	καφέ	Μωβ	πορτοκαλί	δεν είναι κατ'επιλημμένος
(PL)	czarny	biały	szaro	zielony	czerwony	niebiesko	żółty	brazowy	fioletowy	pomarańczowy	wolny
(CZ)	černý	bílý	šedý	zelený	červený	modrý	žlutý	hnědý	fialový	oranžový	neobsazen
(TR)	siyah	beyaz	gri	yeşil	kırmızı	mavi	sarı	kahverengi	mor	portakal rengi	boş
(H)	fekete	fehér	szürke	zöld	piros	kék	sárga	barna	ibolyakék	narancssárga	nem foglalt
(HR)	crno	bijelo	sivo	zeleno	crveno	plavo	zuto	smeđe	ljubičasto	narandasto	nije zauzeto
(BUL)	черен	бял	сив	зелен	червен	син	жълт	кафяв	виолетов	оранжев	свободно
(RO)	negru	alb	gri	verde	roșu	albastru	galben	maro	violet	portocaliu	liber
(RU)	черный	белый	серый	зеленый	красный	голубой	жёлтый	коричневый	пурпурный	оранжевый	свободно
(LT)	juoda	balta	pilka	žalia	raudona	mėlyna	geltona	ruda	purpurinė	oranžinė	laisva
(LV)	melna	balta	pelēka	zaļa	sarkana	zila	dzeltena	brūna	purpur-sarkana	oranža	brīvs
(EST)	must	valge	hall	roheline	punane	sinine	kollane	pruun	purpur-punane	oraanž	vaba
(SLO)	črna	bela	siva	zelena	rdeča	modra	rumena	smeđ	vijoličast	oranžen	ni zasedeno
(SK)	čierny	biely	šedý	zelený	červený	modrý	žltý	hnedý	fialový	pomarančový	neobsadený

8

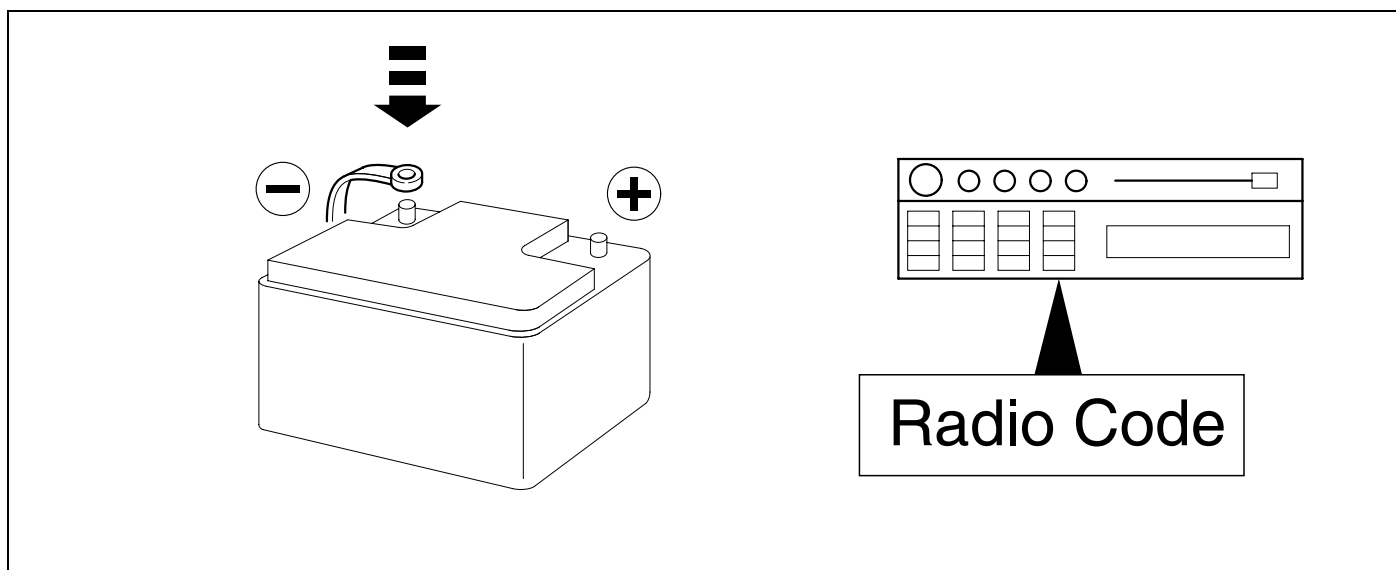

9 CHECK

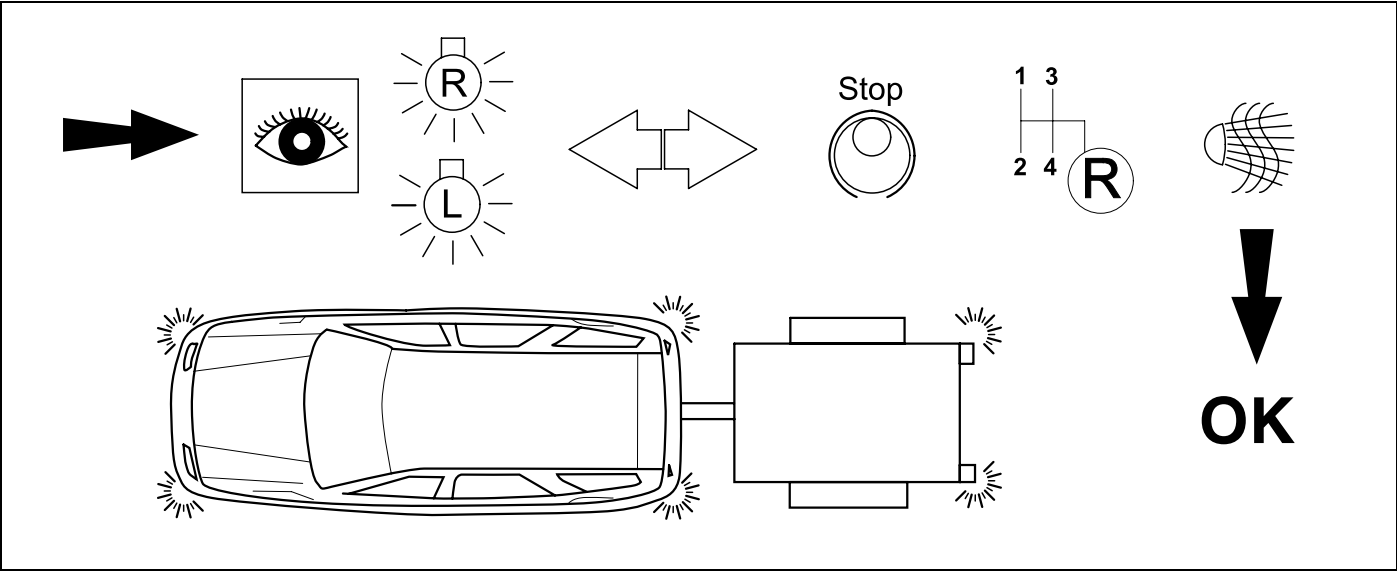

10

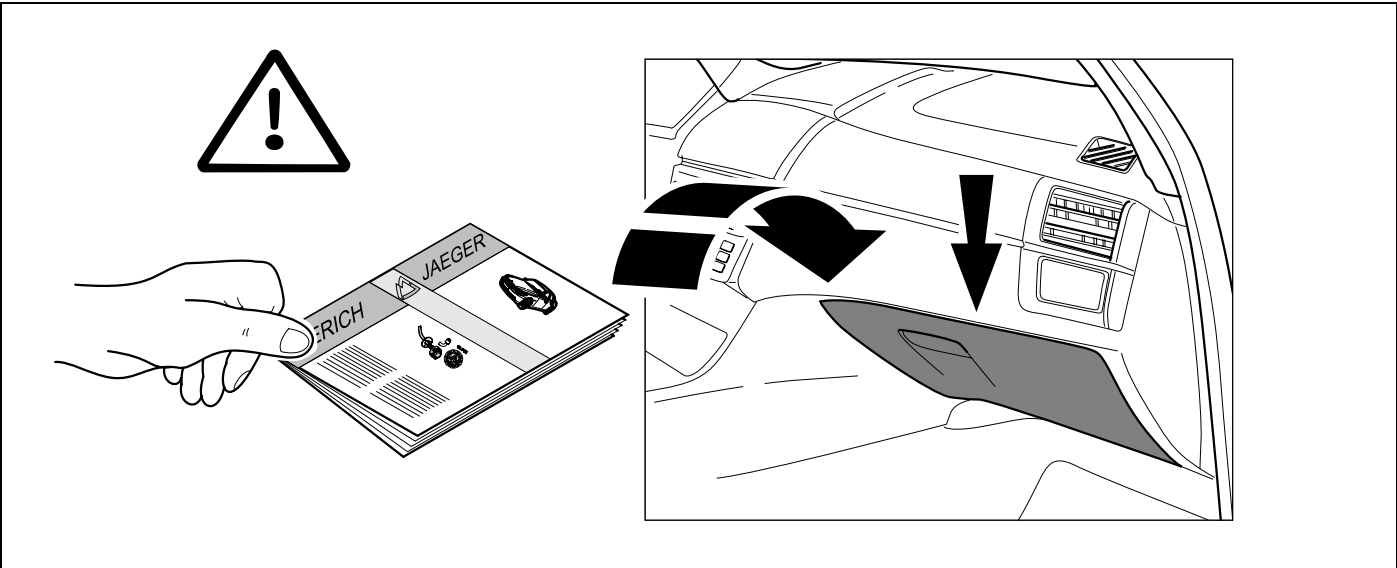

D	Änderungen bezüglich Konstruktion, Ausstattung Farbe sowie Irrtum vorbehalten. Angaben und Abbildungen unverbindlich	PL	Zastrzega się prawo do zmian dot. konstrukcji, wykończenia, kolorystyki oraz pomyłek. Dane i ilustracje niewiążące.
GB	Subject to change in terms of construction, equipment and colour, and may contain errors. The information and illustrations are non-binding.	TR	Tasarım, donanım ve renk bakımından deęişiklik yapma hakkı ve hata ve eksiklik mahfuzdur. Veriler ve resimler baęlayıcı deęildir.
F	Sous réserve de modifications de la construction, de équipement, de la couleur et sous réserve d'erreurs. Les indications et les illustrations sont sans engagement.	H	A szerkezet, a kivitel és a szín változtatása, valamint a változások joga fenntartva. Az adatok és az ábrák nem kötelező érvényűek.
NL	Wijzigingen met betrekking tot constructie, uitvoering en kleur evenals vergissingen voorbehouden. Gegevens en afbeeldingen niet bindend.	HR	Pravo promjena u svezi konstrukcije, opreme, boje kao i zabune oridžavamo. Podaci i ilustracije su neobavezne.
DK	Ændringer med hensyn til konstruktion, udstyr, farver samt fejl forbeholdes. Oplysninger og illustrationer er uforpligtende.	BUL	Запазени права по отношение на конструкцията, обзавеждането, цвѐта и грешки. Данните и изображенията не са обвързваци.
N	Ændringer angående konstruksjon, utstyr, farge og feiltagelse forbeholdes. Oplysninger og illustrasjoner uforbindtlig.	RO	Ne rezervăm dreptul unor modificări ale construcției, dotării, culorii și dreptul la erori Datele indicate și imaginile sunt orientative.
S	Med reservation för ändringar vad det gäller konstruktion, utrustning, färg samt för misstag. Uppgifterna och bilderna är inte bindande.	RU	Права на внесение изменений относительно конструкции, оснащения, окраски, а также на ошибки сохраняются. Данные и иллюстрации имеют примерный характер.
FIN	Pidätämme oikeuden rakennetta, varustusta, väriä koskeviin sekä erehdyksestä johtuviin muutoksiin. Tiedot ja kuvat eivät ole sitovia.	LT	Pasilieikama konstrukcijos, įrangos bei reikmenų, spalvos pakeitimų ir klaidų teisė. Duomenys ir iliustracijos neįpareigojantys.
I	Con riserva di modifche relative a progettazione, dotazione, colore ed errori. Le indicazioni e figure sono fornite senza impegno.	LV	Tiek paturētas tiesības uz konstrukcijas, iekārtu, krāsu izmaiņam, kā arī kļūdīšanās. Dati un attēli bez saistībām.
E	Reservadas las modificaciones respecto a diseño, equipamiento, color, así como error. Indicaciones y figuras sin compromiso.	EST	Konstruktsiooni, varustuse ja võervi osas muudatused ning eksimine lubatud. Andmed ja joonised on mittesiduvad.
P	Reservamos o direito de alterações relativamente ao desenho, equipamento, cor, bem como de erro. Os dados e as gravuras não implicam compromisso da nossa parte.	SLO	Zadržana pravica do sprememb glede konstrukcije, opreme, barve ter pomote. Podatki in slike so neobvezne.
GR	Διατηρώνουμε κάθε επιφύλαξη ως προς αλλαγές σε σχέση με κατασκευή, εξοπλισμό, διαρρύθμιση, χρωματισμούς και λάθη παραδρομής.	SK	Zmeny, ktoré sa týkajú konštrukcie, vybavenia, farby, ako aj omyly sú vyhradené. Údaje a zobrazenia sú nezáväzné.
CZ	Změny, týkající se konstrukce, vybavení, barvy, jakož i omyly jsou vyhrazeny. Údaje a vyobrazení jsou nezávazné.		