



KIA Niro 5D, Hybrid

2016 -

Cat. No. K/066

E20

E20 55R-01 5407

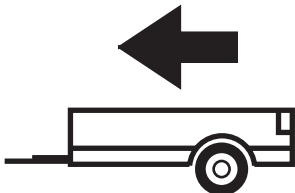

1300kg

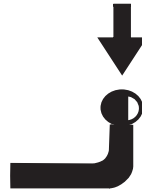

100kg

D = 7,62kN

D (kN) =



MAX kg

x

MAX kg

x 0,00981



MAX kg

+

MAX kg



IMIOLA HAK-POL

96-111 KOWIESY, CHOJNATA 23A, POLAND

Tel. + 48 46 831 73 31, fax +48 831 74 29

e-mail: office@imiola.pl, www.imiola.pl

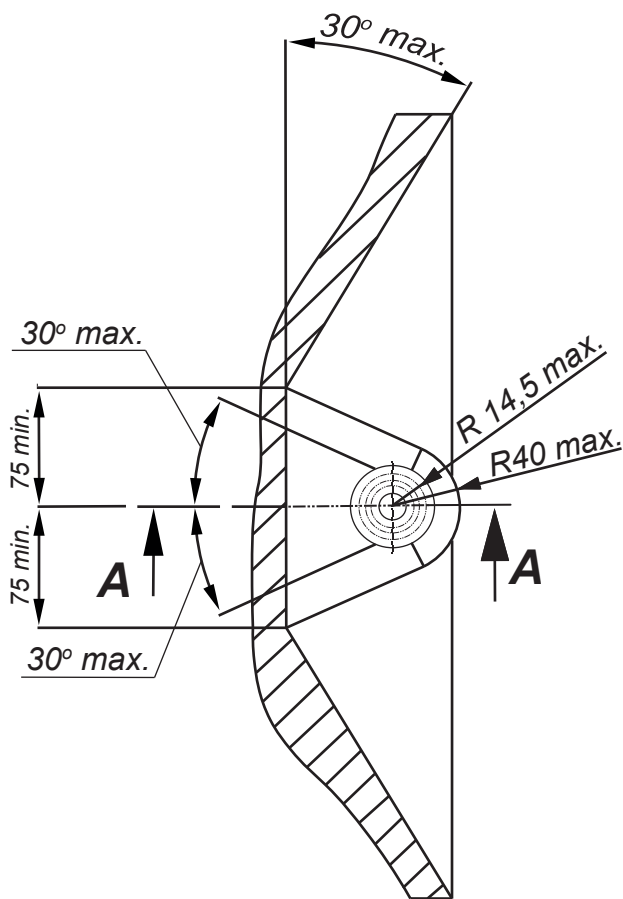

PRZEKRÓJ A-A

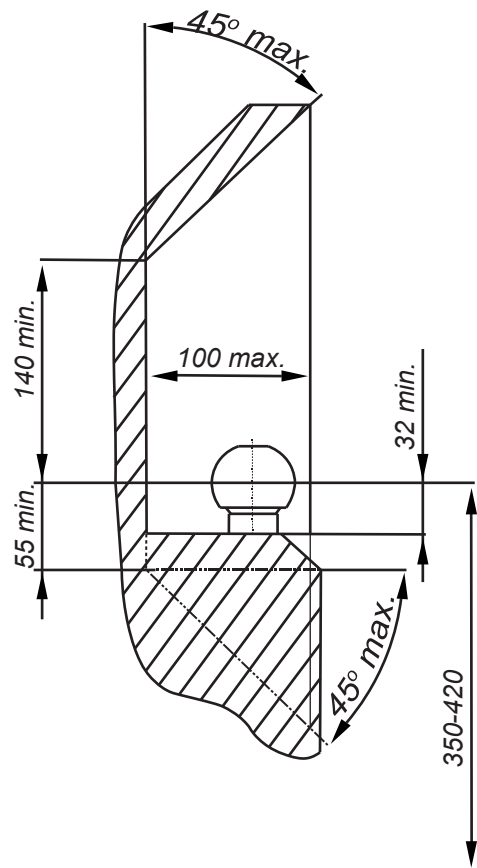

PL Należy zagwarantować przestrzeń swobodną według załącznika VII, rysunek 25a/b Regulaminu EKG ONZ 55.01 przy dopuszczalnym ciężarze całkowitym pojazdu.

F L'espace libre doit être garanti conformément à l'annexe VII, illustration de la réglementation 55.01 CE pour un poids total en charge autorisé du véhicule.







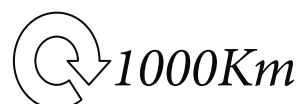

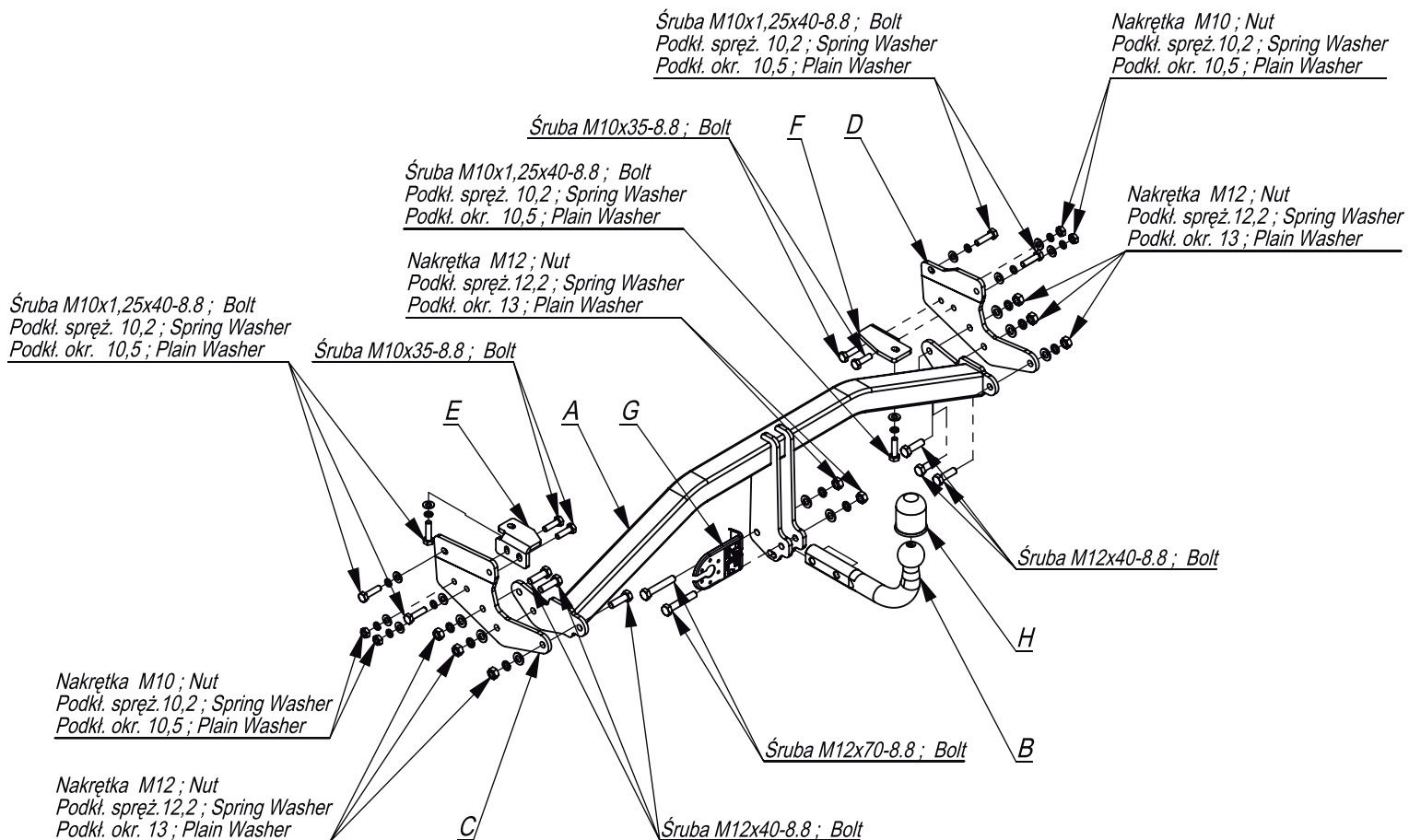

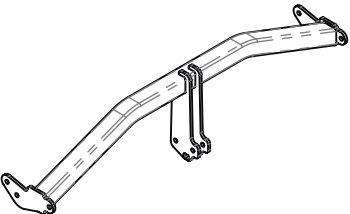
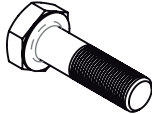
GB The clearance specified in appendix VII, diagram 25a/b of Regulation No. 55.01 UN EU must be guaranteed at laden weight of the vehicle.

D Der Freiraum nach Anhang VII, Abbildung 25a/b der Vorschriften 55.01 EG ist zu gew 25a/b abzuhalten bei zulässigem Gesamtgewicht des Fahrzeuges.

Moment skręcający dla śrub i nakrętek (8.8) Torgue settings for nuts and bolts (8.8)	
M8	25Nm
M10	55Nm
M12	85Nm
M14	135Nm
M16	195Nm





	A	x1		M12x70	2
				M12x40	6
				M10x1,25x40	6
				M10x35	4
	B	x1		M12	8
				M10	4
	C	x1		13	8
				10,5	10
	D	x1		12,2	8
				10,2	10
	E	x1			
	F	x1			
	G	x1			
	H	x1			

- Desenrosque las cubiertas de plástico de la parte inferior del parachoques.
- Desenrosque las lámparas, el parachoques y el refuerzo.
- Limpiar los orificios tecnológicos roscada en los largueros.
- Fijar los elementos C y D del gancho a los largueros con tornillos M10x1, 25x40, 8.8 (art. 4).
- Fijar los elementos E y F del gancho con tornillos M10x1.25x40 8.8 (art. 3) a los largueros y los tornillos M10x35 8.8 a los elementos C y D (punto 2).
- Atornillar la viga de la bola de remolque A a los elementos C y D usando tornillos M12x40 8.8 (punto 1).
- Apretar todos los tornillos con el par según la tabla anterior.
- Apretar la bola y la placa de la toma eléctrica.
- Conectar la instalación eléctrica.

- Unscrew the lamps, bumper and wheel arches.
- Clean out the technological holes with threads in the frame side members.
- Screw the elements C and D to the metal clamps with bolts M10x1,25x35 8.8 (point 4).
- Screw the element E and F to the frame side members with bolts M10x1,25 8.8 (point 3) and to the elements C and D with bolts M12x40 8.8 (point 2).
- Screw the main bar A to the elements C and D with bolts M12x40 8.8 (point 1).
- Tighten all the bolts according to the torque setting- see the table.
- Connect the electric wires.
- Fix the ball and electric plate.

- Dévissez les couvercles en plastique dans la partie inférieure du pare-chocs.
- Dévissez les lampes, le pare-chocs et le renfort.
- Insérer les éléments d'accouplement C et D dans les longerons et visser légèrement (point 1) avec les vis M12x40 8.8.
- Déboucher les fileté trous technologiques dans des longerons.
- Les éléments a crochets C et D doivent être vissés sur les longerons à l'aide de boulons M10x1,25x40 8.8 (point 4).
- Les éléments de crochet E et F doivent être boulonnés avec des boulons M10x1.25x40 8.8 (point 3) avec les longerons et aux boulons M10x35 8.8 aux éléments C et D (point 2).
- Pour les éléments C et D, fixer l'attelage A avec les boulons M12x40 8.8. (point 1).
- Serrer tous les boulons avec un couple de serrage selon tableau.
- Brancher l'installation électrique. Visser la boule et la tôle de la prise électrique.

- Die Kunststoffabdeckungen im unteren Teil des Stoßfängers abschrauben.
- Die Rückleuchten, die Stoßstange und Verstärkung abschrauben.
- Die Gewindebohrungen in den Längsträgern säubern.
- Die AHK-Bauteile C und D mit Schrauben M10x1,25x40 8.8 an den Längsträgern festschrauben (Punkt 4).
- Die AHK-Bauteile E und F mit Schrauben M10x1,25x40 8.8 (Punkt 3) an die Längsträger und mit Schrauben M10x35 8.8 an die Bauteile C und D (Punkt 2) anschrauben.
- Den AHK-Querträger A an die Bauteile C und D mit Schrauben M12x40 8.8 anschrauben (Punkt 1).
- Ziehen Sie alle Schrauben mit dem Drehmoment gemäß der Tabelle an.
- Die elektrische Installation anschließen.
- Die AHK-Kugel und die Steckdosenplatte festziehen.

- Odkręcić osłony plastikowe w części dolnej zderzaka.
- Odkręcić lampy, zderzak i wzmocnienie.
- Udrożnić technologiczne otwory z gwintami w podłużnicach.
- Elementy haka C i D przykręcić do podłużnic śrubami M10x1,25x40 8.8 (pkt 4).
- Element haka E i F przykręcić śrubami M10x1,25x40 8.8 (pkt 3) do podłużnic oraz śrubami M10x35 8.8 do elementów C i D (pkt 2).
- Do elementów C i D przykręcić belkę haka A śrubami M12x40 8.8 (pkt 1).
- Dokręcić wszystkie śruby z momentem wg tabeli.
- Podłączyć instalację elektryczną.
- Dokręcić kulę i blachę gniazda elektrycznego.

