

Einbauanleitung Elektrosatz
Anhängervorrichtung mit 12-N Steckdose
lt. DIN/ISO Norm 1724

Instructions de montage du faisceau
électrique pour crochet d'attelage
conforme à la norme
DIN/ISO 1724 prise 12-N

Fitting instructions electric wiringkit
towbar with 12-N socket up to
DIN/ISO norm 1724

Montage-handleiding elektrokabelset voor
trekhaak met 12-N contactdoos
vlgs. DIN/ISO norm 1724

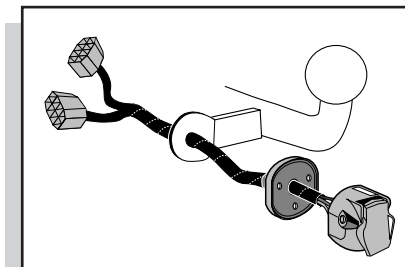

OPEL ZAFIRA 1999-

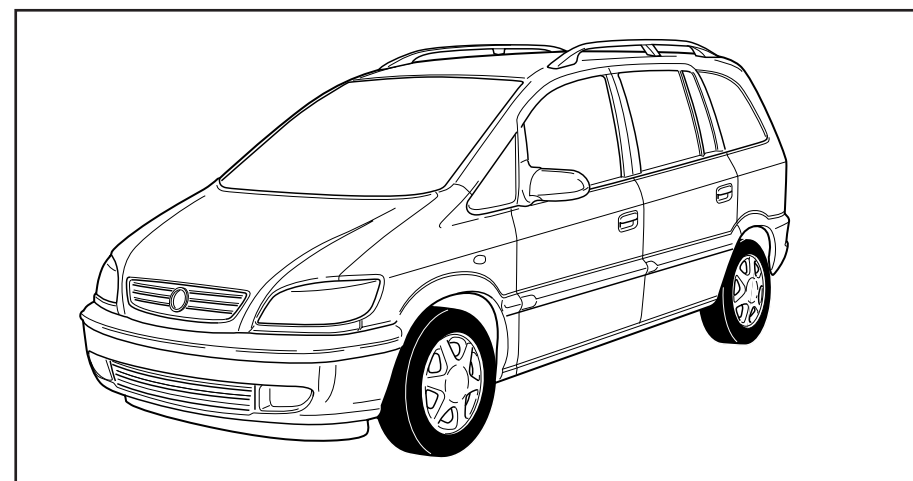

Bestel Nr.: OP-009-BB

* Teilliste

* Liste de pieces

* Part list

* Onderdelenlijst

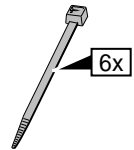
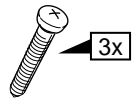
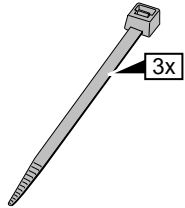
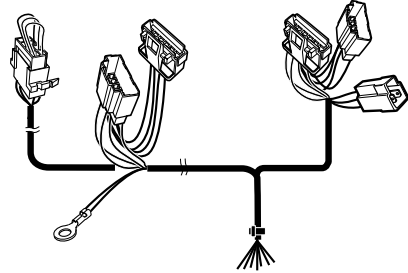
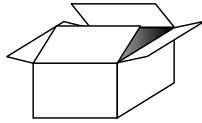

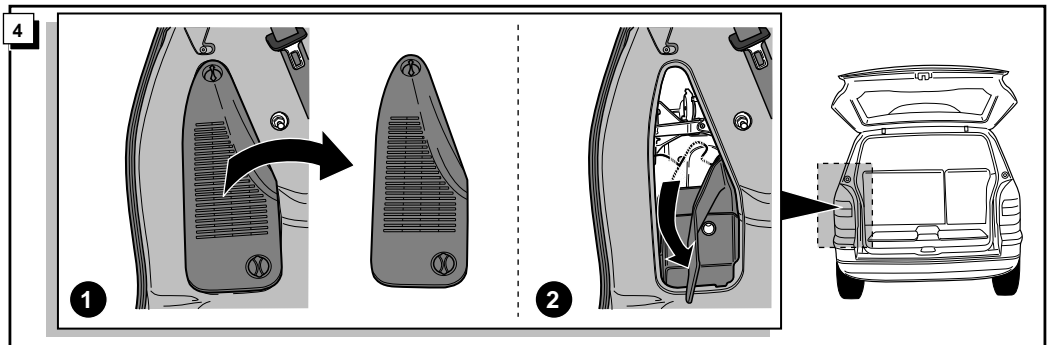
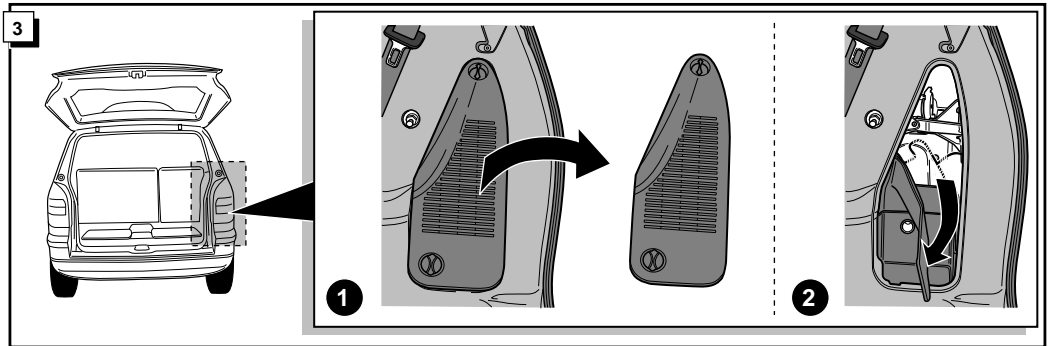
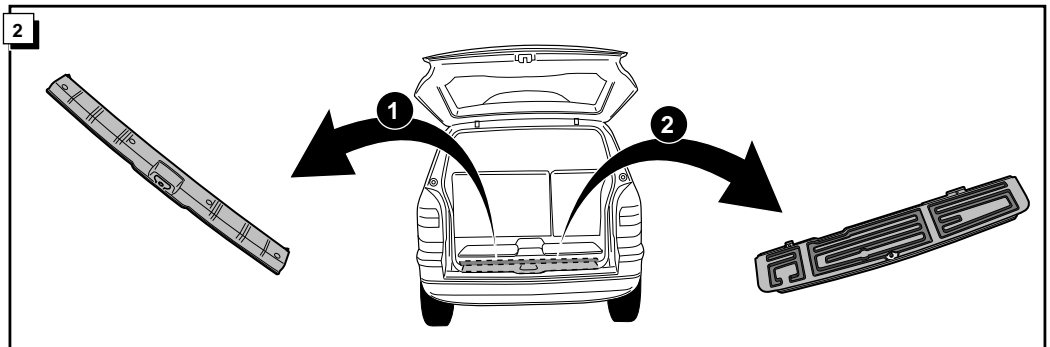
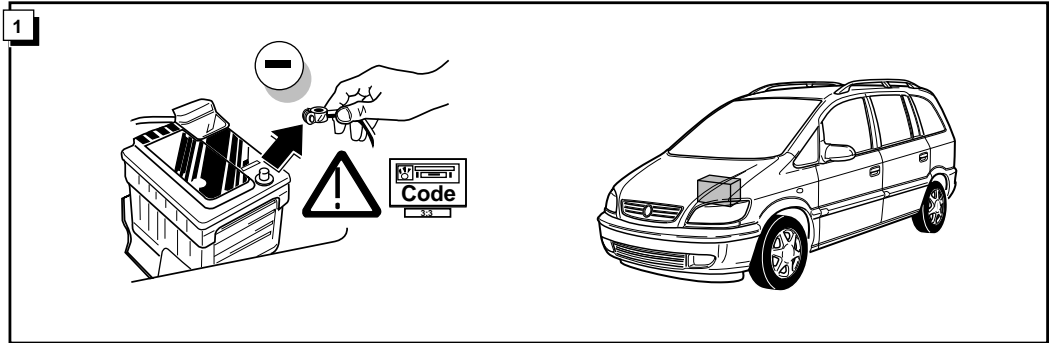

INFO

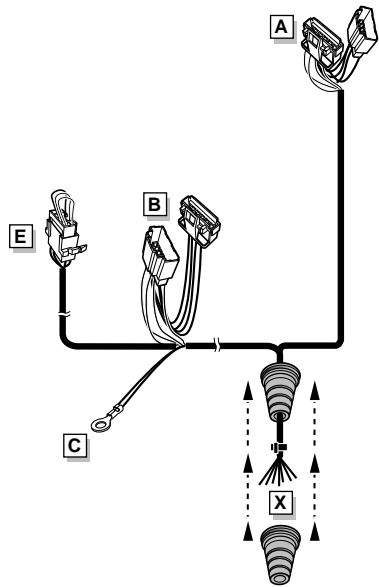

ROUTING

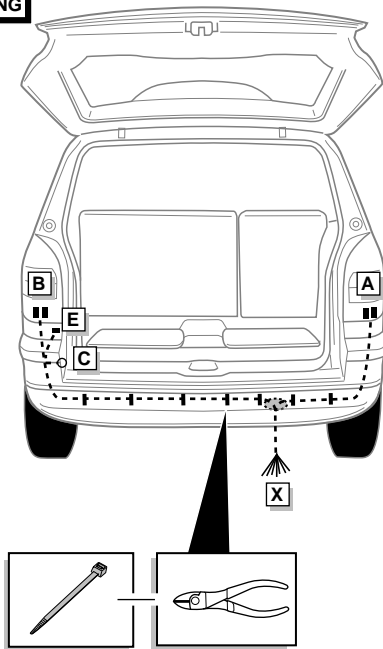

5

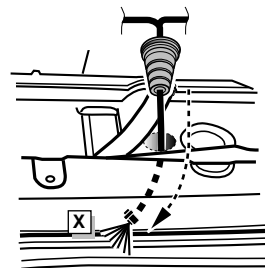
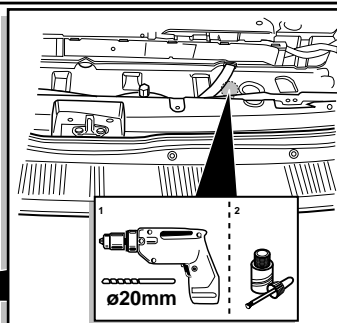
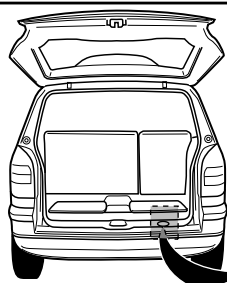

INFO

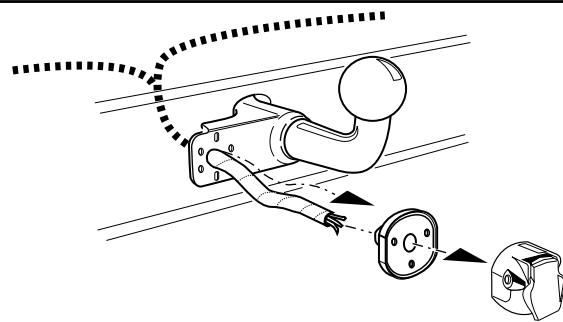

DIN/ISO 1724		D	F	GB	NL
	1/L	gelb	jaune	yellow	geel
	2	blau	bleu	blue	blauw
	3/31	weiß	blanc	white	wit
	4/R	grün	vert	green	groen
	5/58-R	braun	marron	brown	bruin
	6/54	rot	rouge	red	rood
	7/58-L	schwarz	noir	black	zwart
	8/58-b	grau	gris	grey	grijs

6

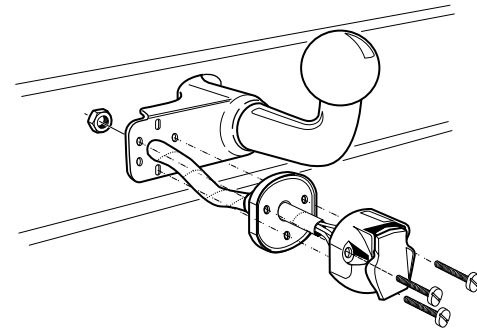

7

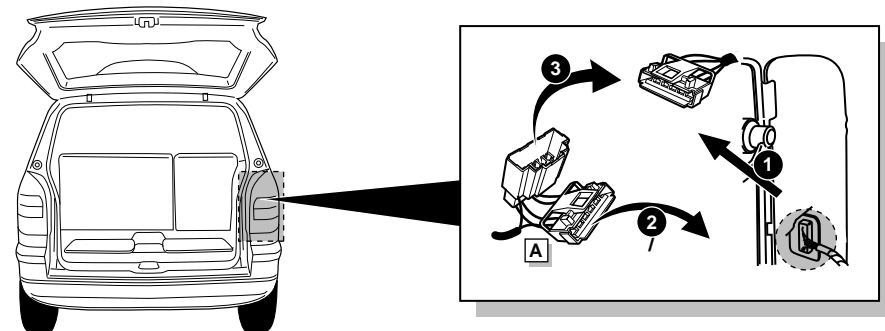

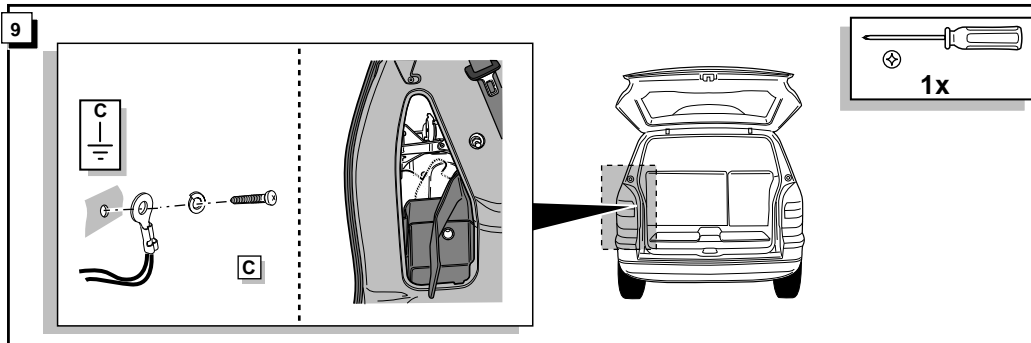
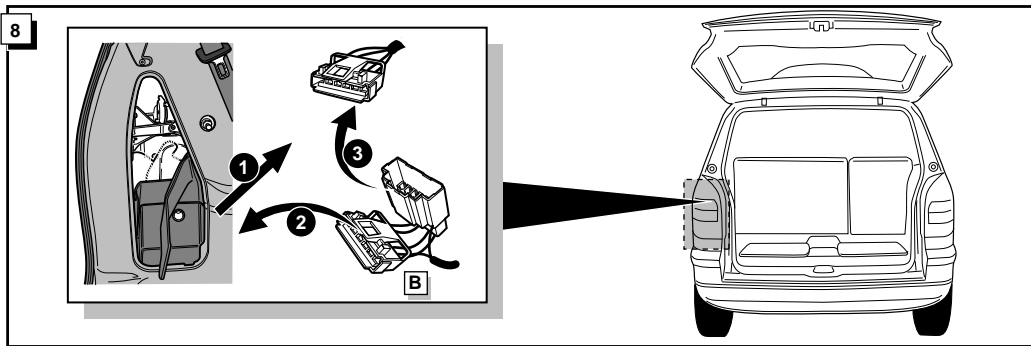

10

- * Mit Check control: bei ihrem Lieferanten nach einem Erweiterungssatz informieren.
- * Avec check control: Informez chez votre fournisseur pour un faisceau d'extension.
- * With check control: contact your supplier for an extension kit.
- * Met check control: informeer bij uw leverancier naar een uitbreidingsset.

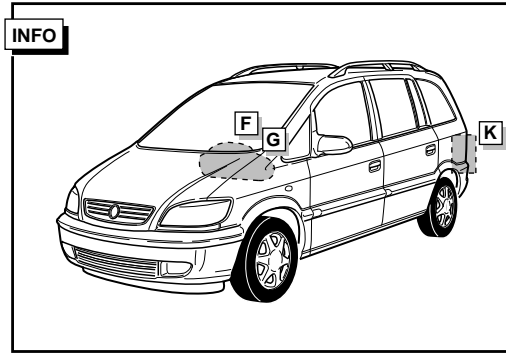

INFO

Erweiterungssatz für Fahrzeuge mit Check Control.
 Faisceau d'extension pour véhicules avec check control.
 Extension kit for vehicles with check control.
 Uitbreidingsset voor voertuigen met check control.

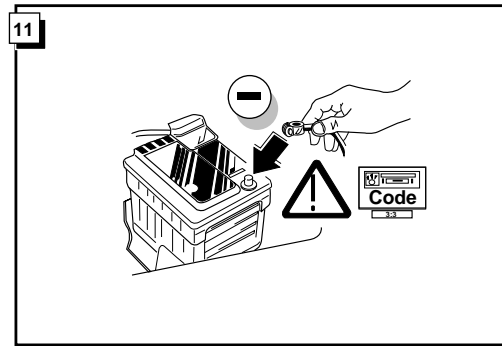
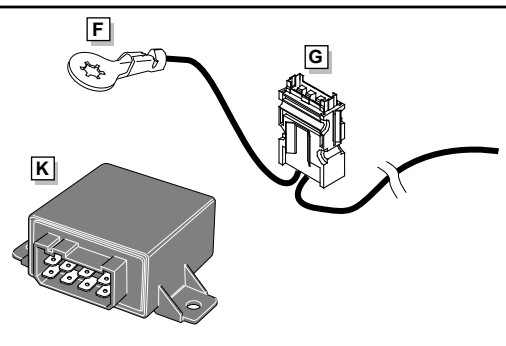

12

FUNKTIONEN KONTROLIEREN !
CONTRÔLER LES FONCTIONS !
CHECK FUNCTIONS !
CONTROLEER FUNCTIES !

